

12' x 20' x 8' Garage-in-a-Box® Peak Style Shelter Assembly Instructions

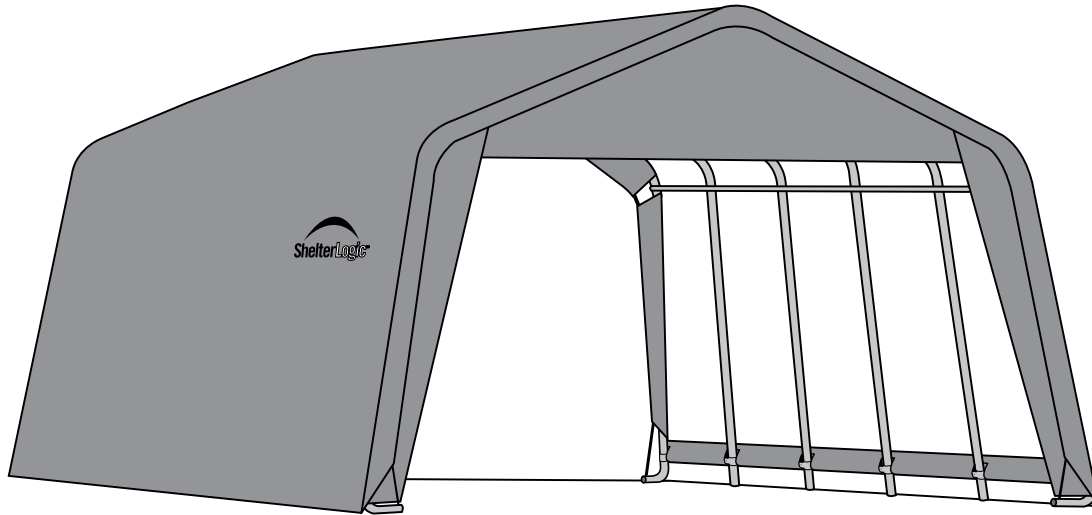

DESCRIPTION	MODEL #
12' x 20' x 8' Garage-in-a-Box® - Gray	62790

RECOMMENDED TOOLS

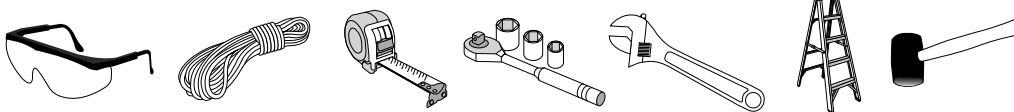

Please read instructions **COMPLETELY** before assembly. This shelter **MUST** be securely anchored. THIS IS A TEMPORARY STRUCTURE AND NOT RECOMMENDED AS A PERMANENT STRUCTURE.

Before you start: 2+ individual recommended for assembly, approximate time 2 hr.

150 Callender Road
Watertown, CT 06795
www.shelterlogic.com

**VIEW AN ONLINE INSTRUCTIONAL
VIDEO OF A GARAGE BEING BUILT!**
www.ShelterLogic.com

1-800-524-9970

Canada:
1-800-559-6175

ATTENTION:

This shelter product is manufactured with quality materials. It is designed to fit the **ShelterLogic®**, LLC custom fabric cover included. **ShelterLogic®**, LLC Shelters offer storage and protection from damage caused by sun, light rain, tree sap, animal - bird excrement and light snow. Please anchor this **ShelterLogic®**, LLC structure properly. See manual for more anchoring details. Proper anchoring, keeping cover tight and free of snow and debris is the responsibility of the consumer. Please read and understand the installation detail, warnings and cautions prior to beginning installation. If you have any questions call the customer service number listed below. Please refer to the warranty card inside this package.

DANGER:

Prior to installation, consult with all local municipal codes regarding installation of temporary shelters. Choose the location of your shelter carefully. **DANGER: Keep away from electrical wires.** Check for overhead utility lines, tree branches or other structures. Check for underground pipes or wires before you dig. DO NOT install near roof lines or other structures that could shed snow, ice or excessive run off onto your shelter. DO NOT hang objects from the roof or support cables.

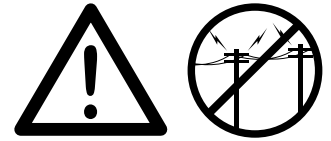

WARNING:

Risk of fire. DO NOT smoke or use open flame devices (including grills, fire pits, deep fryers, smokers or lanterns) in or around the shelter. DO NOT store flammable liquids (gasoline, kerosene, propane, etc.) in or around your shelter. Do not expose top or sides of the shelter to open fire or other flame source.



CAUTION:

Use **CAUTION** when erecting the frame. Use safety goggles during installation. Secure and bolt together overhead poles during assembly. Beware of pole ends.

PROPER ANCHORING AND INSTALLATION OF FRAME:

PROPER ANCHORING OF THE FRAME IS THE RESPONSIBILITY OF THE CONSUMER.

ShelterLogic®, LLC is not responsible for damage to the unit or the contents from acts of nature. Any shelter that is not anchored securely has the potential to fly away causing damage, and is not covered under the warranty. Periodically check the anchors to ensure stability of shelter. **ShelterLogic®**, LLC cannot be responsible for any shelter that blows away. **NOTE:** *Your shelter's cover can be quickly removed and stored prior to severe weather conditions.* If strong winds or severe weather is forecast in your area, we recommend removal of cover.

REPLACEMENT PARTS, ASSEMBLY, SPECIAL ORDERS:

Genuine **ShelterLogic®**, LLC replacement parts and accessories are available from the factory, including anchoring kits for nearly any application, replacement covers, wall and enclosure kits, vent and light kits, frame parts, zippered doors and other accessories. All items are shipped factory direct to your door.

QUESTIONS - CLAIMS - SPECIAL ORDERS? CALL OUR CUSTOMER SERVICE HOTLINE:

U.S. CUSTOMER SERVICE: 1-800-524-9970 INTERNATIONAL CUSTOMER SERVICE: 001-860-945-6442 CANADA CUSTOMER SERVICE: 1-800-559-6175

HOURS OF OPERATION: MON-FRI 8:30AM-8:00PM EST, SAT-SUN 8:30AM-5:00PM EST.

CARE AND CLEANING:

A tight cover ensures longer life and performance. Always maintain a tight cover. Loose fabric can accelerate deterioration of cover fabric. Immediately remove any accumulated snow or ice from the roof structure with a broom, mop or other soft-sided instrument. Use extreme caution when removing snow from cover- always remove from outside the structure. DO NOT use hard-edged tools or instruments like rakes or shovels to remove snow. This could result in punctures to the cover. DO NOT use bleach or harsh abrasive products to clean the fabric cover. Cover is easily cleaned with mild soap and water.

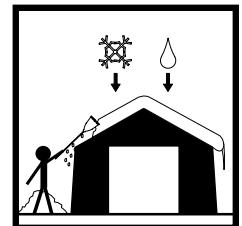

WARRANTY:

This shelter carries a full limited warranty against defects in workmanship. **ShelterLogic®**, LLC warrants to the Original Purchaser that if properly used and installed, the product and all associated parts, are free from manufacturer's defects for a period of:











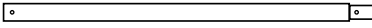
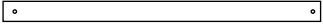
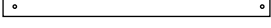
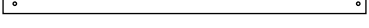





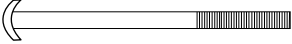

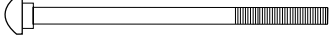

1 YEAR FOR COVER FABRIC, END PANELS AND FRAMEWORK

Warranty period is determined by date of shipment from **ShelterLogic®**, LLC for factory direct purchases or date of purchase from an authorized reseller, (please save a copy of your purchase receipt). If this product or any associated parts are found to be defective or missing at the time of receipt, **ShelterLogic®**, LLC will repair or replace, at it's option, the defective parts at no charge to the original purchaser. Replacement parts or repaired parts shall be covered for the remainder of the Original Limited Warranty Period. All shipping costs will be the responsibility of the customer. Parts and replacements will be sent C.O.D. You must save the original packaging materials for shipment back. If you purchased from a local dealer, all claims must have a copy of original receipt. After purchase, please fill out and return warranty card for product registration. Please see warranty card for more details.

Covered by U.S. Patents and patents pending: 6,871,614; 6,994,099; 7,296,584; D 430,306; D 415,571; D 414,564; D 409,310; D 415,572

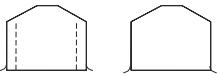
080310

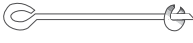
12'3" x 20' x 8'3" Garage-in-a-Box® Parts List - Model #62790

Description of Parts:		Quantity	Part #
	Rafter / Cross Rail 48 1/2"	15	802130
	Cross Rails, Swedge 49 3/4"	12	802129
	Cross Rails 46 1/8"	10	802695
	Corner Tube 39 1/2"	4	802694
	Middle Poles 49 5/8"	8	802693
	Corner Leg Bends	4	802637
	Side Corners	12	802692
	Top Connectors	6	802691
	Steel Foot Plate	8	12270
	ShelterLock™	12	800597
	Ratchet Clamp	8	10240
	Round Head Bolts 1/4" x 3"	6	802630
	Bolts 1/4" x 1 5/8"	32	10115
	Bolts 1/4" x 1 7/8"	36	03032
	Bolts 1/4" x 3"	12	10210
	Washer 1/4"	20	01011
	Nut 1/4"	86	01010
	White Bungee Cords (For holding door open)	2	10066
	Bolt Caps (For bolt 10210)	12	10150
	Half-Clamps for Middle Legs	16	13201
	Half-Clamps for Corner Legs	8	13202
	Cover	1	800292
	2-Zipper Door	1	800318
	Back Panel	1	800317
	15" Auger Anchors (Temporary)	4	10014
	Cable - 1' Length	4	10015
	Cable Clamps	4	10016

1. LAY OUT ROOF FRAME

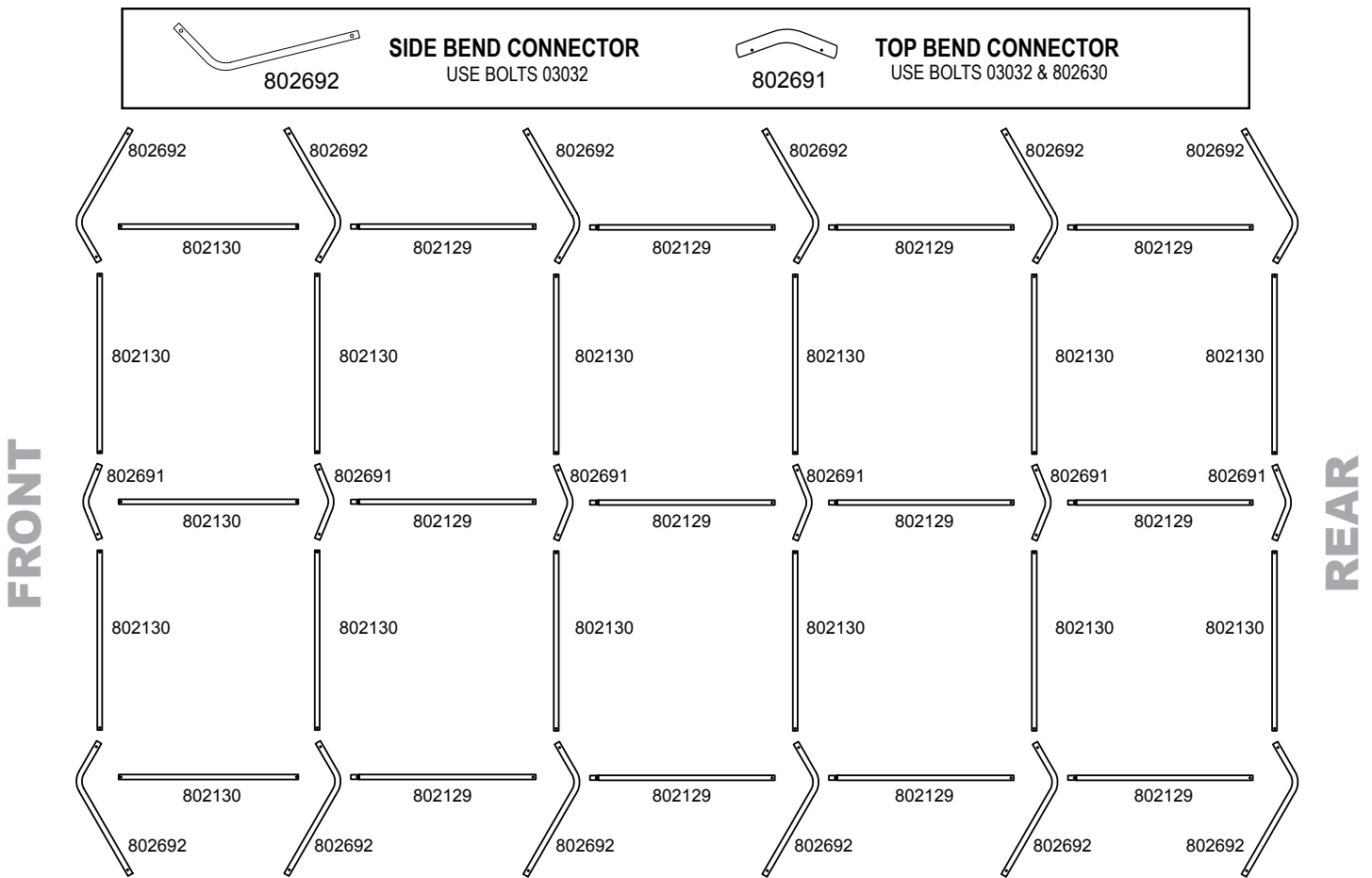

2. ASSEMBLE ROOF FRAME Use bolts as shown in illustrations.

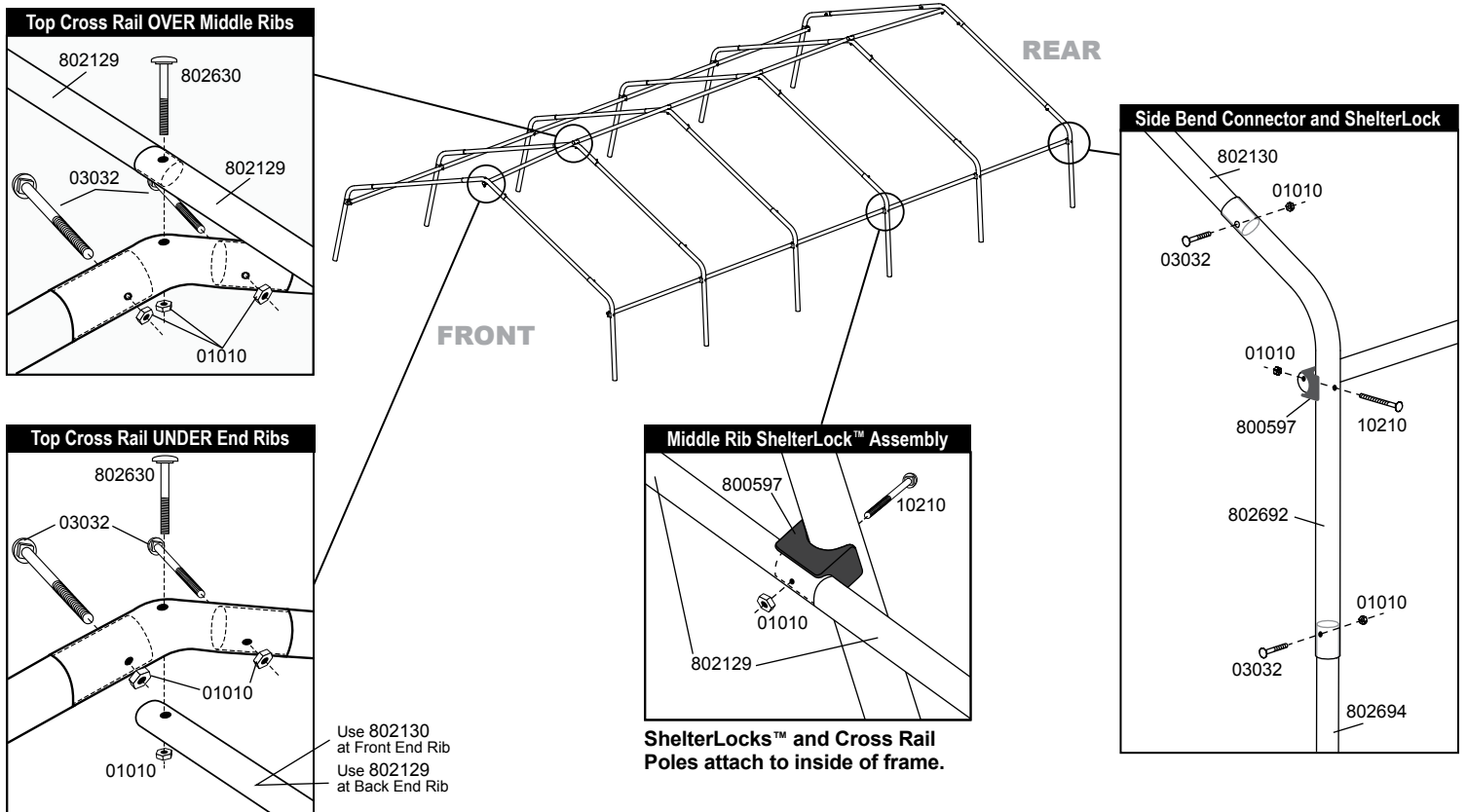

3. ASSEMBLE LEGS & ATTACH TO ROOF FRAME *Use bolts as shown in illustrations.*

- A. Assemble Corner and Middle legs.
- B. Attach legs with bolts on one side of roof frame, let the other side of roof frame rest on the ground.
- C. Attach remaining legs with bolts to opposite side of roof frame.

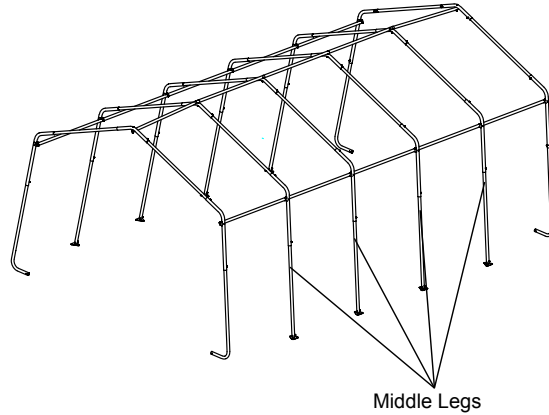
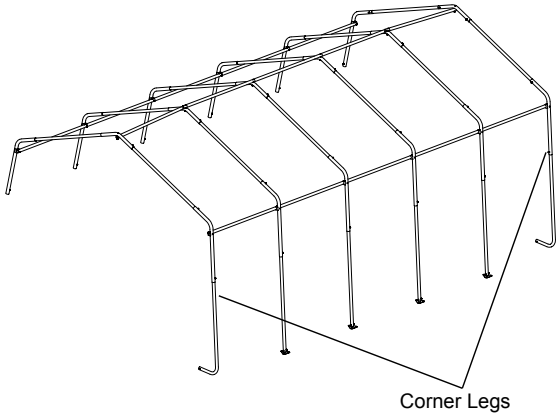
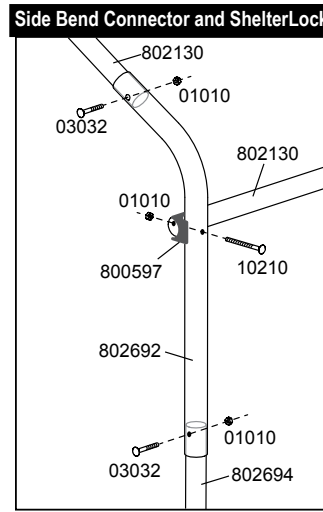
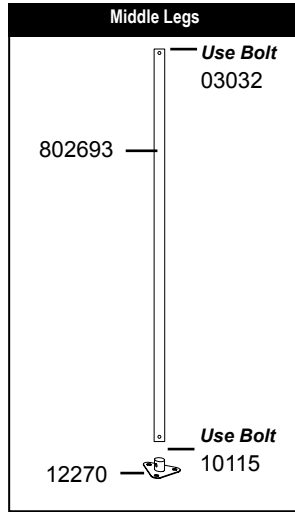
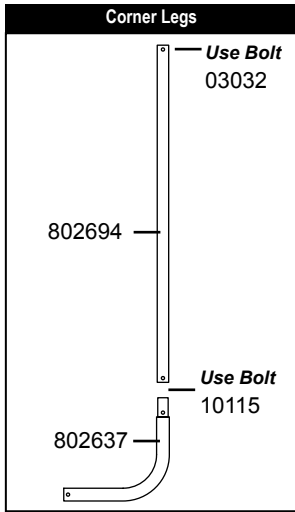

4. ASSEMBLE COVER RAILS

- A. Place the cover rail (802695) at each leg and secure it at each leg with a cover clamp as shown below.
- B. Slide the cover rails so they are 8 inches up from the ground and **hand tighten bolts on clamps**.

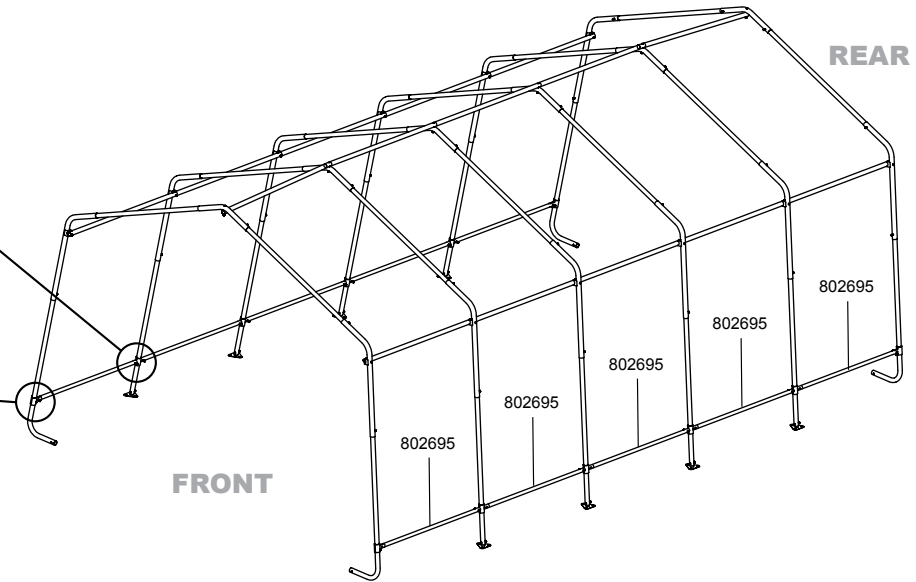
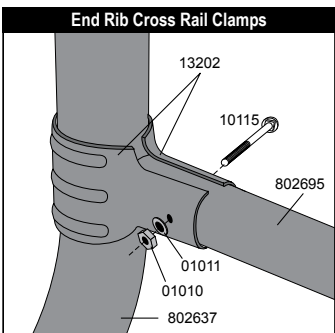
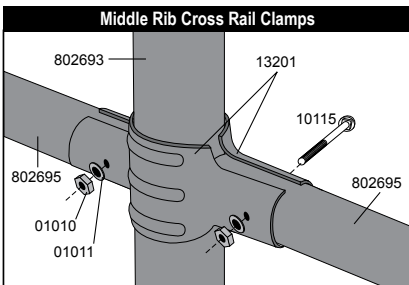

5. SQUARING UP THE FRAME

- A. Place frame in its final location, which needs to be as flat and level as possible.
- B. Measure across opposite corners. **These distances must be equal to within 1 inch.**
- C. Check that the front and rear of the frame measures 12 feet 3 inches in width.

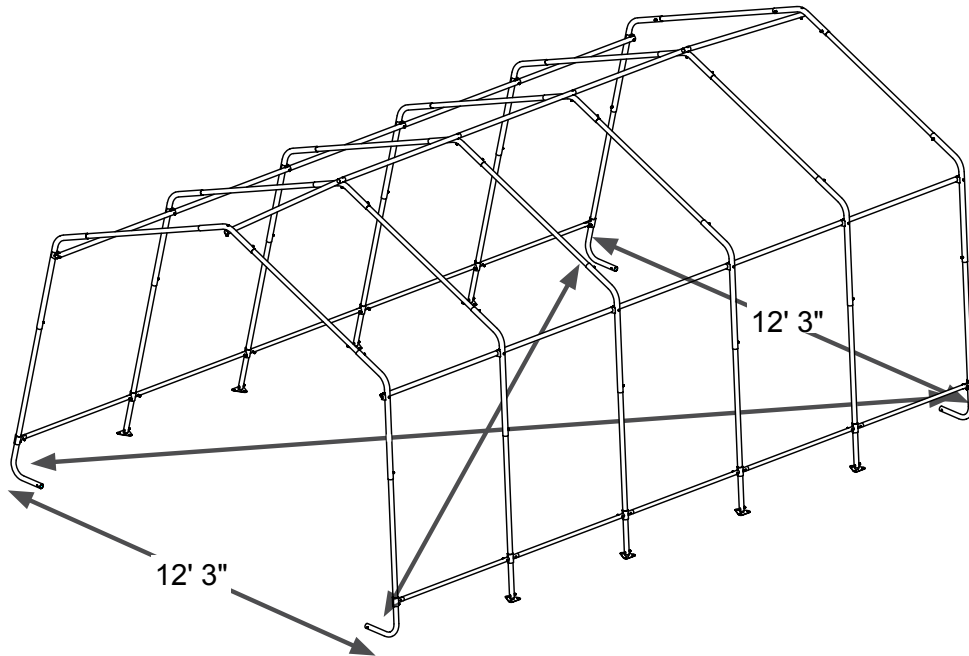

6. PROPERLY ANCHOR THE FRAME

- A. Anchors must be placed inside shelter at the corners of the shelter.
- B. Insert a 3/4-inch pipe or steel rod, through the eyelet of the anchor and screw the anchor into the ground until the eyelet is sticking out of the ground by 1 to 2 inches so it can be anchored to the legs.
If ground is too hard, dig a hole with a shovel or post hole tool. Optional: Fill with cement.
- C. Wrap cable provided through the eyelet of the anchor and around the frame as shown below. Secure the cable with the clamps provided.

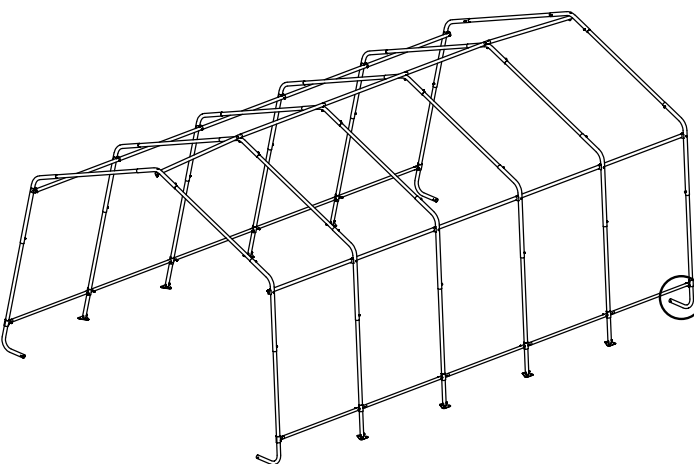

NOTE:

15" Augers are for temporary use only! For best results ShelterLogic recommends using our Easy Hooks (#10036 4-pack, #10035 6-pack, or #10038 8-pack) or 30" Augers (#10075 4-pack, #10078 6-pack, or #10079 8-pack) for a stronger, more secure installation.

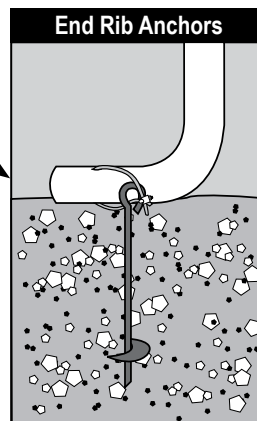

Call 1-800-524-9970 or visit www.shelterlogic.com for more information.

7. DOOR AND SOLID END PANEL INSTALLATION

- A. Hold end panel at the top center with white inner surface facing inside of the shelter. Wrap the edges of the fabric panel around the end rib.
- B. Disconnect top rail (the horizontal pipes that run from front to back along the top) from the end rib. Pull the webbing (the black strap) below the cross rail. Reattach the top cross rail to the end rib. Repeat Step B for side rails (the horizontal pipes that run from front to back along the sides of the unit, near the bend in the frame where the legs meet the roof).
- C. At the bottom, where the webbing exits the pocket on each side of end panel, pull webbing to remove the slack. **Be careful not to pull the webbing through the other side of the webbing pocket.**
- D. Insert the "S"- Hook on ratchet into hole on the leg bend. Insert the webbing into the spindle of the ratchet and pull tight. Wind the ratchet so that the webbing overlaps itself.

Position the end panel so that it is centered on the building before fully tightening the end panel.

- E. Tighten ratchets, alternating from one side to the other, until the end panel is centered and tight.

Zipper Door Panels: Zippers must be closed when tightening end panel.

NOTE: Keep Zippers closed when tightening end panels.

WRAP END PANEL EDGES OVER AND AROUND PIPE TOWARDS INSIDE OF FRAME.

IMPORTANT! DO NOT INSERT ANY PIPES INTO THESE POCKETS.

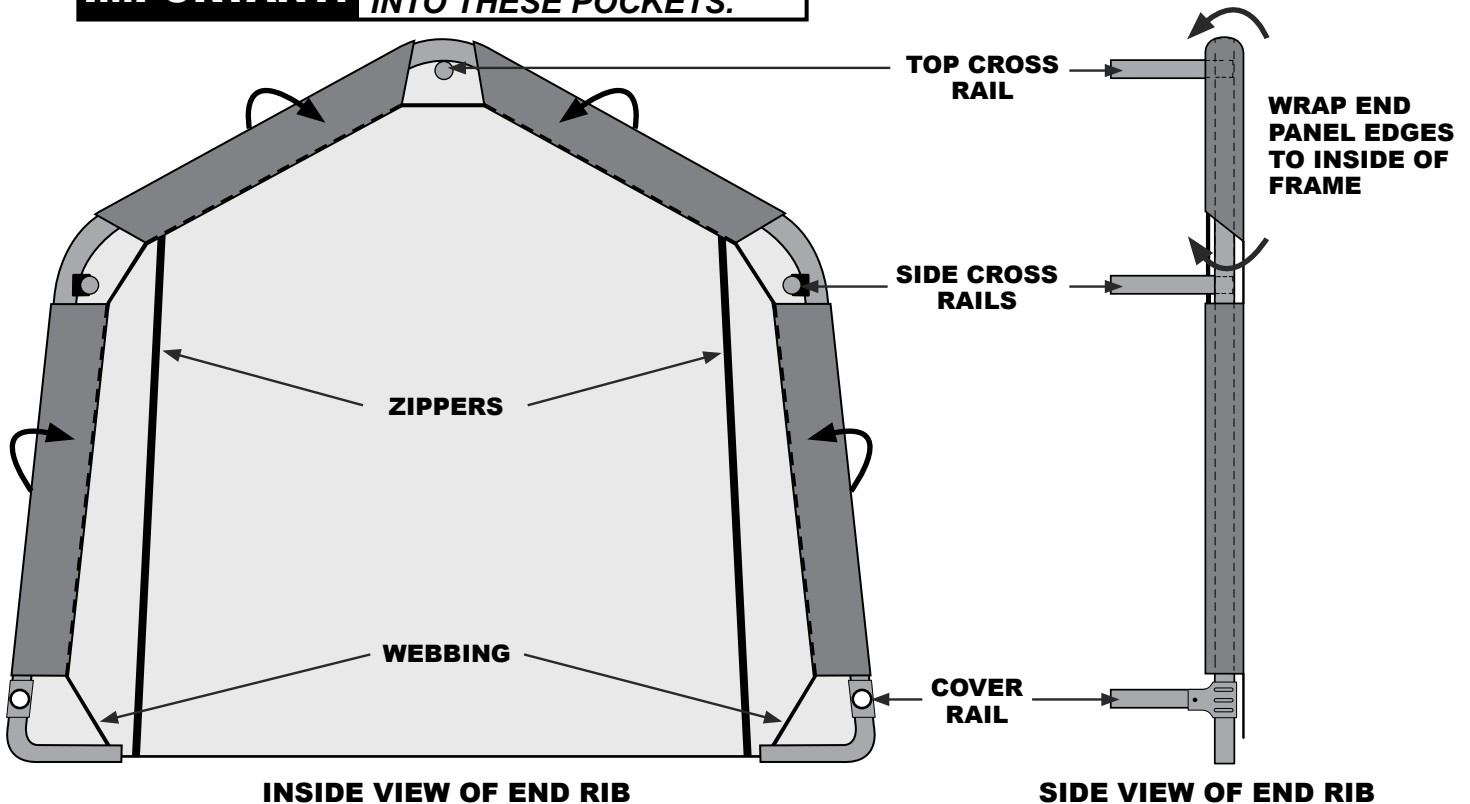

Thread Webbing Into Ratchet

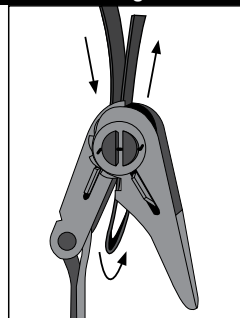

Webbing and Ratchets Securing End Panel

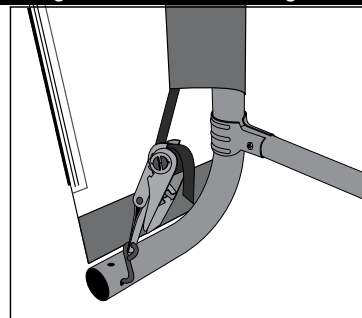

8. INSTALLING COVER AND COVER RAILS

- A. Lay the cover on the ground next to the frame with inside of the cover (the side with the pipe pockets) facing down and the webbing on the front and rear of the corner of the building.
- B. Pull cover over the frame, making sure to center cover on frame. There should be an equal amount of overhang at all four corners.
- C. Insert the "S"- Hook on ratchet into hole on the leg bend. Insert the webbing into the spindle of the ratchet and pull tight. Wind the ratchet so that the webbing overlaps itself.
- D. Disassemble cover rails and slide through fabric pockets at each leg and reattach with clamps to each leg. Repeat this on other side. Push down on cover rails to tighten cover, before tightening bolts completely.
- E. Check and tighten Ratchets and Cover Rails monthly to ensure the cover is tight.

NOTE: The ShelterLogic® logo should be oriented as shown below.

